



乐博达
Leboda

Be Bright · Be Happy



2018
PRODUCT CATALOG



COMPANY PROFILE

Ningbo Leboda Lighting Technology Co.,Ltd. is an international integrated professional lighting supplier, dedicated to R&D, manufacturing and exporting of high-end qualified lighting products with the most reasonable price for customers. The main product ranges are LED street light, LED high bay light, LED flood light, LED tunnel light and LED garden lights.

We are based on know-how team, working on good heat dissipation technology with ADC 12 Die-casting aluminum body, optics system, LED chip and LED power supply including 10KV surge protection, to guarantee 5-year warranty.

Nowadays, our products are widely welcomed by many key strategic customers and popular in more than 20 countries all over the world.

The comprehensive customer service ability, independent product development ability and diversified supply-chain management will enable our clients, our partner suppliers and ourselves develop and expand quite in the good system.



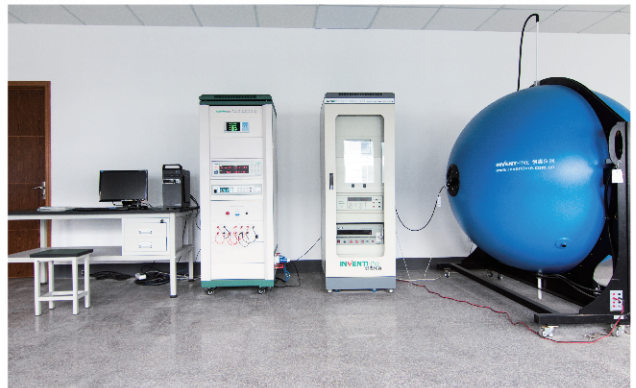

SUPERLINE - LED STREET LIGHTS

灯具可以横装和竖装 Vertical and horizontal installation are both ok.

Personalized Configuration

Internal components can be configured according to customer requirements meet the personalized needs.



Photocell Available

Lamp will automatically turn on and off according to lux difference.

Breath filter

Lamp breath filter ensures air balance inside and outside of the lamp which improved lamp lifespan.

Surge protection device

To provide more reliable guarantee for led drive power extend the life of the product.

Safety switch

Auto switch cut off power when opening the light, more safety.

LED power supply

A variety of power driver is optional, MeanWell & Inventronics and etc.

Toolless clips

To open the light housing body without tool, for easy maintenance.

LED chip

High quality of LED components, CREE XTE, Lumileds SMD and etc.

Optics system

Correct optics solution with high quality lens from LEDiL, Ledlink and Herculux to meet different road requirements.

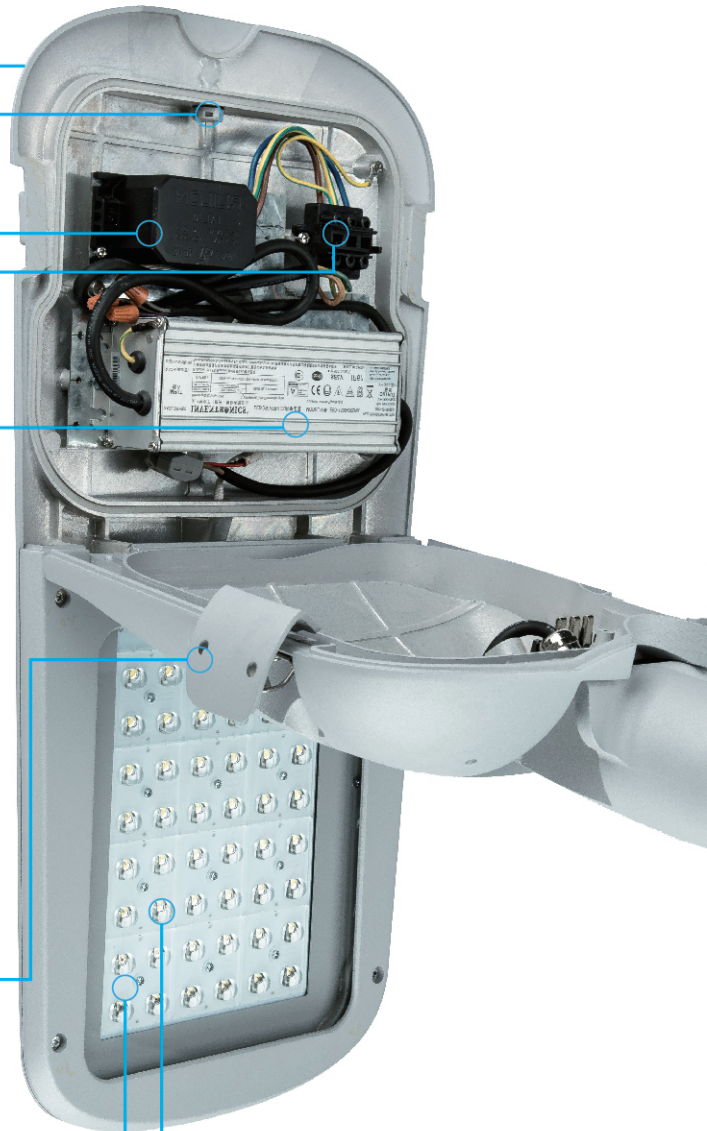

SUPERLINE SMALL

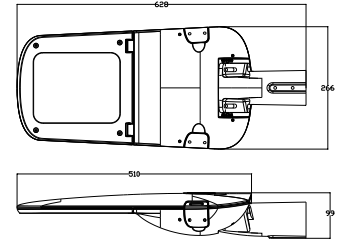

产品尺寸 Product Dimension



光控 (可选) Photocell (optional)

无线单灯控制器 (可选) Wireless single lamp controller (optional)

防雷器 (可选) Surge protector (optional)

断电保护器 (可选) Cut-off Switch (optional)

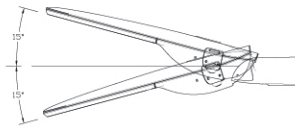

灯具水平安装, 可调角度为 ±15°
Luminaire tilt adjustment, side entry: -15° to +15°

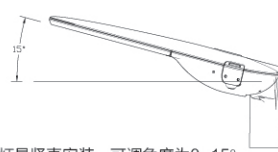

灯具竖直安装, 可调角度为 0~15°
Luminaire tilt adjustment, post top: 0° to +15°

Features:

- Patented modern and fashionable streamline design
- Smooth type of roof is for excellent self-cleaning, to avoid bird droppings, falling leaves and sand storms.
- Rib-free outside housing, but good heat sink technology to enable the whole body with highest rate of heat dissipation and to make sure that LED component is working at lower junction temperature.
- High quality ADC 12 aluminum die-casting and power painting.
- Top brand of LED components, CREE XTE or Lumileds 5050SMD
- Correct optic lens family from LEDIL or LedLink to satisfy any kind of road requirement
- High quality LED power supply from Meanwell or Inventronics with 5-year warranty, including 6KV of surge protection. 10/20KV is possible with additional SPD.
- Toolless clips of opening for easy maintenance.

产品技术参数表 Product Specification

产品型号	Product Code	LBD-S05S-30	LBD-S05S-60
输入功率	Input Wattage	30W	60W
LED 数量	LED quantity	16	24
色温	Color Temperature	3000-6500K	3000-6500K
初始光通量	Luminous Flux	3900Lm ± 5%	7800Lm ± 5%
输入电压	Input Voltage	AC100-277V	AC100-277V
频率范围	Frequency Range	50/60Hz	50/60Hz
功率因素	Power Factor	PF ≥ 0.9	PF ≥ 0.9
显示指数	color rendering index	Ra ≥ 70	Ra ≥ 70
工作环境温度	Temperature of Working Condition	-40--50°C	-40--50°C
工作环境湿度	Humidity of Working Condition	20%-90%	20%-90%
LED寿命	LED Lifetime	50000h	50000h
防护等级	Protectin Grade	IP66	IP66
安装管径	Installation Pipe Diameter	φ 48mm/ φ 60mm	φ 48mm/ φ 60mm
安装高度	Installation Height	4-6m	6-8m
净重	Net Weight	5.50kg	5.50kg
毛重	Gross Weight	6.50kg	6.50kg
包装尺寸	Packing Size	660*340*160mm	660*340*160mm

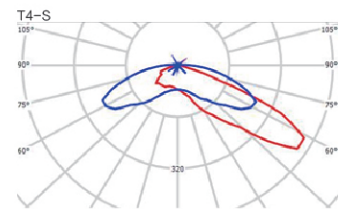
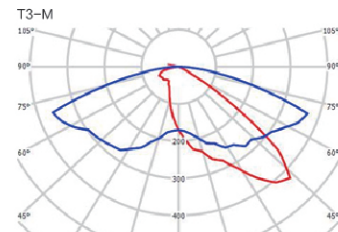
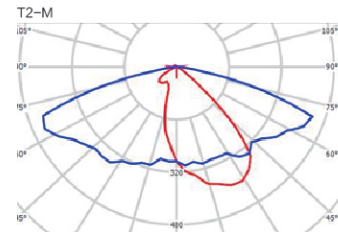

注意: 包装尺寸为外尺寸
本表所示技术参数均在环境温度为 25°C, 湿度 35% 的实验环境中测得
Packing size is outer size of box.
eters are measured at 25°C ambient, 35% humidity experimental environment

SUPERLINE MEDIUM



 金属灰
 Metal Grey
  砂纹黑
 Black
  闪银沙
 silver

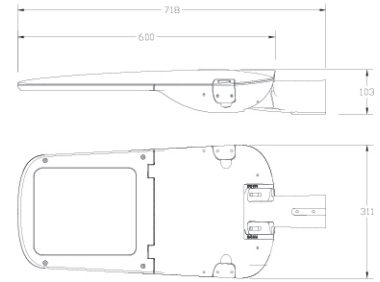

产品尺寸 Product Dimension



光控 (可选)
Photocell
(optional)



无线单灯控制器 (可选)
Wireless single lamp controller
(optional)

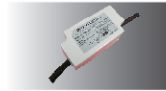

防雷器 (可选)
Surge protector
(optional)



断电保护器 (可选)
Cut-off Switch(optional)

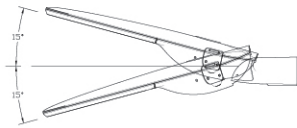

灯具水平安装, 可调角度为±15°
Luminaire tilt adjustment, side entry: -15° to +15°

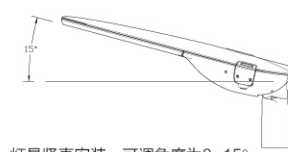

灯具竖直安装, 可调角度为0-15°
Luminaire tilt adjustment, post top: 0° to +15°

Features:

- Patented modern and fashionable streamline design
- Smooth type of roof is for excellent self-cleaning, to avoid bird droppings, falling leaves and sand storms.
- Rib-free outside housing, but good heat sink technology to enable the whole body with highest rate of heat dissipation and to make sure that LED component is working at lower junction temperature.
- High quality ADC 12 aluminum die-casting and power painting.
- Top brand of LED components, CREE XTE or Lumileds 5050SMD
- Correct optic lens family from LEDiL or LedLink to satisfy any kind of road requirement
- High quality LED power supply from Meanwell or Inventronics with 5-year warranty, including 6KV of surge protection. 10/20KV is possible with additional SPD.
- Toolless clips of opening for easy maintenance.

产品技术参数表 Product Specification

产品型号	Product Code	LBD-S05M-90	LBD-S05M-120
输入功率	Input Wattage	90W	120W
LED 数量	LED quantity	36	48
色温	Color Temperature	3000-6500K	3000-6500K
初始光通量	Luminous Flux	11700Lm ± 5%	15600Lm ± 5%
输入电压	Input Voltage	AC100-277V	AC100-277V
频率范围	Frequency Range	50/60Hz	50/60Hz
功率因素	Power Factor	PF ≥ 0.9	PF ≥ 0.9
显示指数	color rendering index	Ra ≥ 70	Ra ≥ 70
工作环境温度	Temperature of Working Condition	-40--50℃	-40--50℃
工作环境湿度	Humidity of Working Condition	20%-90%	20%-90%
LED寿命	LED Lifetime	50000h	50000h
防护等级	Protectin Grade	IP66	IP66
安装管径	Installation Pipe Diameter	φ 60mm	φ 60mm
安装高度	Installation Height	8-10m	8-10m
净重	Net Weight	7.3kg	7.3kg
毛重	Gross Weight	8.3kg	8.3kg
包装尺寸	Packing Size	780*370*180mm	780*370*180mm

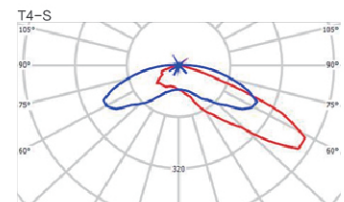
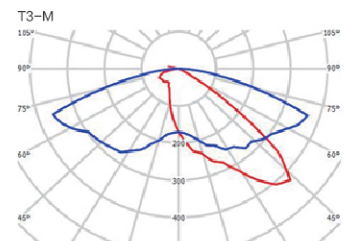
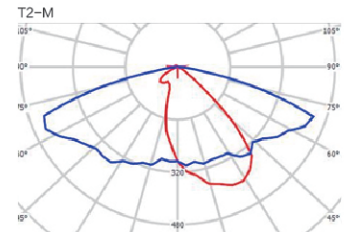

注意: 包装尺寸为外尺寸

本表所示技术参数均在环境温度 25℃, 湿度 35% 的实验室环境中测得

Packing size is outer size of box.

eters are measured at 25℃ ambient, 35% humidity experimental environment



IP66

LED STREET LIGHT



SUPERLINE LARGE



金属灰 Metal Grey
砂纹黑 Black
闪银沙 Silver

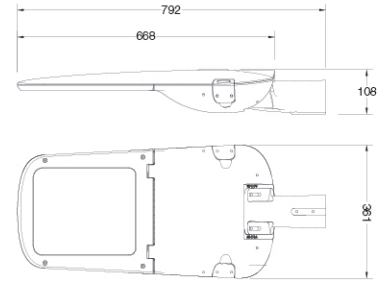

产品尺寸 Product Dimension

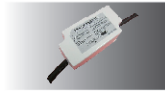
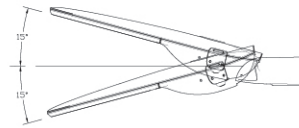
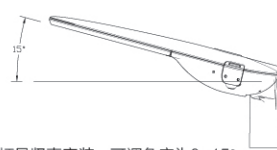
光控 (可选)
Photocell
(optional)无线单灯控制器 (可选)
Wireless single lamp controller
(optional)防雷器 (可选)
Surge protector
(optional)断电保护器 (可选)
Cut-off Switch (optional)灯具水平安装, 可调角度为±15°
Luminaire tilt adjustment, side entry: -15° to +15°灯具竖直安装, 可调角度为0~15°
Luminaire tilt adjustment, post top: 0° to +15°

Features:

- Patented modern and fashionable streamline design
- Smooth type of roof is for excellent self-cleaning, to avoid bird droppings, falling leaves and sand storms.
- Rib-free outside housing, but good heat sink technology to enable the whole body with highest rate of heat dissipation and to make sure that LED component is working at lower junction temperature.
- High quality ADC 12 aluminum die-casting and power painting.
- Top brand of LED components, CREE XTE or Lumileds 5050SMD
- Correct optic lens family from LEDiL or LedLink to satisfy any kind of road requirement
- High quality LED power supply from Meanwell or Inventronics with 5-year warranty, including 6KV of surge protection. 10/20KV is possible with additional SPD.
- Toolless clips of opening for easy maintenance.

产品技术参数表

Product Specification

产品型号	Product Code	LBD-S05L-150	LBD-S05L-180
输入功率	Input Wattage	150W	180W
LED 数量	LED quantity	64	80
色温	Color Temperature	3000-6500K	3000-6500K
初始光通量	Luminous Flux	19500Lm ± 5%	23400Lm ± 5%
输入电压	Input Voltage	AC100-277V	AC100-277V
频率范围	Frequency Range	50/60Hz	50/60Hz
功率因素	Power Factor	PF ≥ 0.9	PF ≥ 0.9
显示指数	color rendering index	Ra ≥ 70	Ra ≥ 70
工作环境温度	Temperature of Working Condition	-40--50℃	-40--50℃
工作环境湿度	Humidity of Working Condition	20%-90%	20%-90%
LED寿命	LED Lifetime	50000h	50000h
防护等级	Protectin Grade	IP66	IP66
安装管径	Installation Pipe Diameter	φ 60mm/φ 76mm	φ 60mm/φ 76mm
安装高度	Installation Height	10-12m	10-12m
净重	Net Weight	9.5kg	9.5kg
毛重	Gross Weight	10.5kg	10.5kg
包装尺寸	Packing Size	860x420x190mm	860x420x190mm

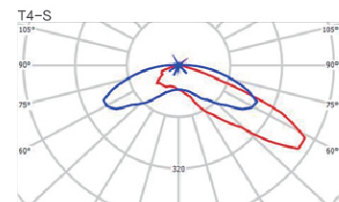
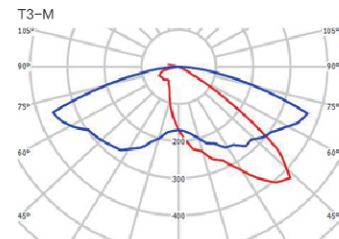
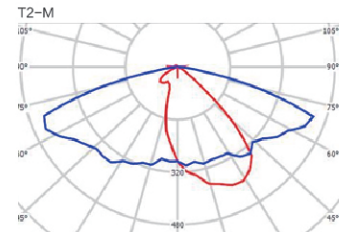

注意: 包装尺寸为外尺寸

本表所示技术参数均在环境温度为 25℃, 湿度 35% 的实验环境中测得

Packing size is outer size of box. Parameters are measured at 25℃ ambient, 35% humidity experimental environment

JASS MINI



 **金属灰**
 Metal Gray
  **砂纹黑**
 Black
  **闪银沙**
 Silver

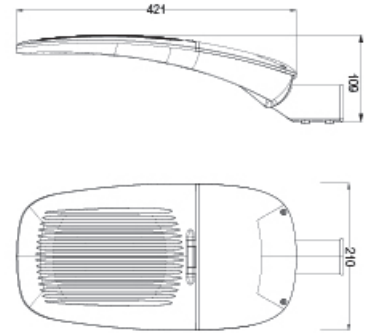

产品尺寸 Product Dimension



光控 (可选)
Photoeye
(optional)



防雷器 (可选)
Surge protector
(optional)



断电保护器 (可选)
Cut-off Switch(optional)

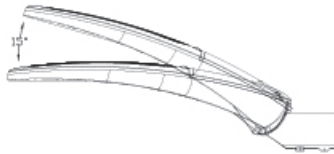

灯具水平安装, 可调角度为0-15°
Luminaire tilt adjustment, side entry: 0° to +15°

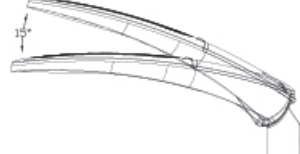

灯具垂直安装, 可调角度为0-15°
Luminaire tilt adjustment, post top: 0° to +15°

Features:

- Patented modern and fashionable streamline design
- Smooth type of roof is for excellent self-cleaning, to avoid bird droppings, falling leaves and sand storms.
- High quality ADC 12 aluminum die-casting and power painting.
- Top brand of LED components, CREE XTE or Lumileds 3030SMD.
- Correct optic lens family to satisfy any kind of road requirement.
- High quality LED power supply from Meanwell or Inventronics with 5-year warranty, including 8KV of surge protection, 10/20KV is possible with additional SPD.

产品技术参数表

Product Specification

产品型号	Product Code	BD-560030SJ	BD-560050SJ
输入功率	Input Wattage	30W	50W
LED 数量	LED quantity	36	72
色温	Color Temperature	3000-6500K	3000-6500K
初始光通量	Luminous Flux	3600Lm ± 5%	6000Lm ± 5%
输入电压	Input Voltage	AC100-277V	AC100-277V
频率范围	Frequency Range	50/60Hz	50/60Hz
功率因素	Power Factor	PF ≥ 0.9	PF ≥ 0.9
显示指数	color rendering index	Ra ≥ 70	Ra ≥ 70
工作环境温度	Temperature of Working Condition	-40--50°C	-40--50°C
工作环境湿度	Humidity of Working Condition	20%~90%	20%~90%
LED寿命	LED Lifetime	50000h	50000h
防护等级	Protectin Grade	IP66	IP66
安装管径	Installation Pipe Diameter	φ 48mm	φ 48mm
安装高度	Installation Height	4-6m	4-6m
净重	Net Weight	3.0kg	3.0kg
毛重	Gross Weight	4.0kg	4.0kg
包装尺寸	Packing Size	520*160*120mm	520*160*120mm

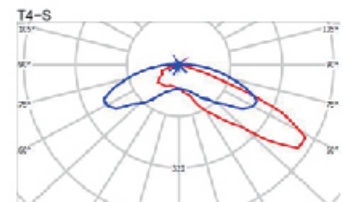
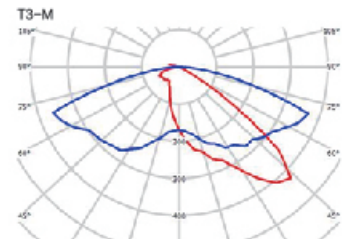
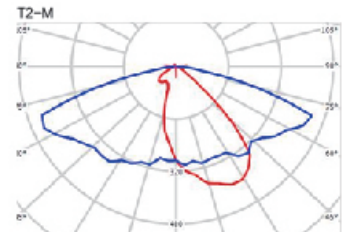

注意: 包装尺寸为外尺寸

本表所示技术参数均在环境温度 25°C, 湿度 35% 的实验室环境中测得

Packing size is outer size of box.
eters are measured at 25°C ambient, 35% humidity experimental environment



IP66

LED STREET LIGHT



JASS SMALL



金属灰 Metal Gray
砂纹黑 Black
闪银沙 Silver

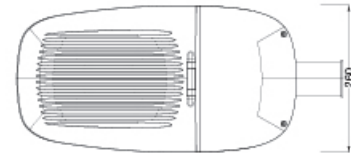
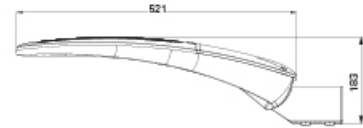

产品尺寸 Product Dimension

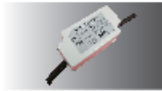
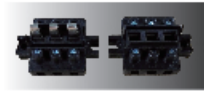
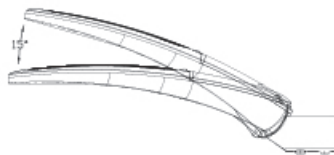
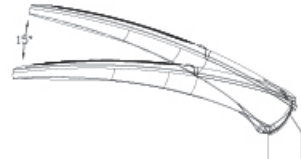
光控 (可选)
Photo cell
(optional)防雷器 (可选)
Surge protector
(optional)断电保护器 (可选)
Cut-off Switch(optional)灯具水平安装, 可调角度为0-15°
Luminaire tilt adjustment, side entry: 0° to +15°灯具竖直安装, 可调角度为0-15°
Luminaire tilt adjustment, post top: 0° to +15°

Features:

- Patented modern and fashionable streamline design
- Smooth type of roof is for excellent self-cleaning, to avoid bird droppings, falling leaves and sand storms.
- High quality ADC 12 aluminum die-casting and power painting.
- Top brand of LED components, CREE XTE or Lumileds 3030SMD.
- Correct optic lens family to satisfy any kind of road requirement.
- High quality LED power supply from Meanwell or Inventronics with 5-year warranty, including 6KV of surge protection. 10/20KV is possible with additional SPD.

产品技术参数表

Product Specification

产品型号	Product Code	BD-560050SJ	BD-560060SJ
输入功率	Input Wattage	50W	60W
LED 数量	LED quantity	24	32
色温	Color Temperature	3000-6500K	3000-6500K
初始光通量	Luminous Flux	6000Lm ± 5%	7200Lm ± 5%
输入电压	Input Voltage	AC100-277V	AC100-277V
频率范围	Frequency Range	50/60Hz	50/60Hz
功率因素	Power Factor	PF ≥ 0.9	PF ≥ 0.9
显示指数	color rendering index	Ra ≥ 70	Ra ≥ 70
工作环境温度	Temperature of Working Condition	-40--50°C	-40--50°C
工作环境湿度	Humidity of Working Condition	20%--90%	20%--90%
LED寿命	LED Lifetime	50000h	50000h
防护等级	Protectin Grade	IP66	IP66
安装管径	Installation Pipe Diameter	φ48mm/φ60mm	φ48mm/φ60mm
安装高度	Installation Height	6-8m	6-8m
净重	Net Weight	5.0kg	5.0kg
毛重	Gross Weight	6.0kg	6.0kg
包装尺寸	Packing Size	680*300*155mm	680*300*155mm

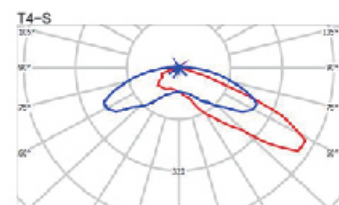
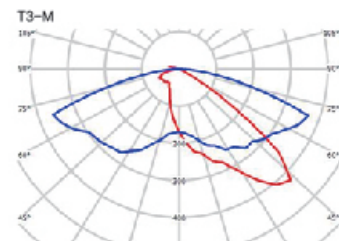
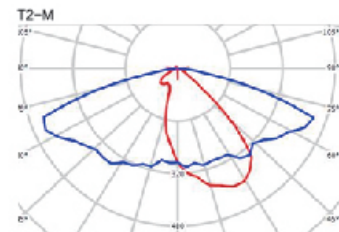

注意: 包装尺寸为外尺寸

本表所示技术参数均在环境温度为 25°C, 湿度 35% 的实验环境中测得

Packing size is outer size of box.
eters are measured at 25°C ambient, 35% humidity experimental environment

JASS MEDIUM



 **金属灰**
 Metal Grey
  **砂纹黑**
 Black
  **闪银沙**
 silver

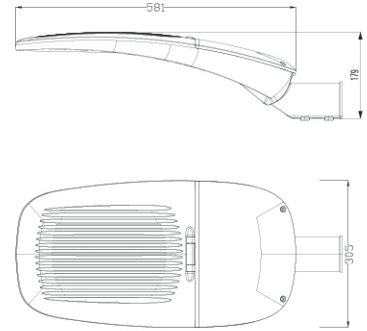

产品尺寸 Product Dimension



光控 (可选)
PhotoCell
(optional)



无线单灯控制器 (可选)
Wireless single lamp controller
(optional)

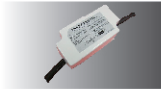

防雷器 (可选)
Surge protector
(optional)



断电保护器 (可选)
Out-of Switch(optional)

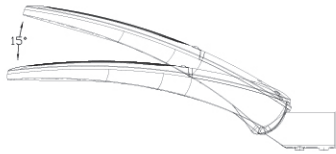

灯具水平安装, 可调角度为0-15°
Luminaire tilt adjustment, side entry: 0° to +15°

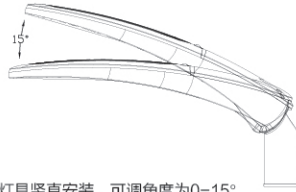

灯具竖直安装, 可调角度为0-15°
Luminaire tilt adjustment, post top: 0° to +15°

Features:

- Patented modern and fashionable streamline design
- Smooth type of roof is for excellent self-cleaning, to avoid bird droppings, falling leaves and sand storms.
- High quality ADC 12 aluminum die-casting and power painting.
- Top brand of LED components, CREE XTE or Lumileds 3030SMD.
- Correct optic lens family to satisfy any kind of road requirement.
- High quality LED power supply from Meanwell or Inventronics with 5-year warranty, including 6KV of surge protection. 10/20KV is possible with additional SPD.

产品技术参数表

Product Specification

产品型号	Product Code	BD-560100SJ	BD-560120SJ
输入功率	Input Wattage	100W	120W
LED 数量	LED quantity	48	60
色温	Color Temperature	3000-6500K	3000-6500K
初始光通量	Luminous Flux	12000Lm ± 5%	14400Lm ± 5%
输入电压	Input Voltage	AC100-277V	AC100-277V
频率范围	Frequency Range	50/60Hz	50/60Hz
功率因素	Power Factor	PF ≥ 0.9	PF ≥ 0.9
显示指数	color rendering index	Ra ≥ 70	Ra ≥ 70
工作环境温度	Temperature of Working Condition	-40--50℃	-40--50℃
工作环境湿度	Humidity of Working Condition	20%-90%	20%-90%
LED寿命	LED Lifetime	50000h	50000h
防护等级	Protectin Grade	IP66	IP66
安装管径	Installation Pipe Diameter	φ 60mm	φ 60mm
安装高度	Installation Height	8-10m	8-10m
净重	Net Weight	6.0kg	6.0kg
毛重	Gross Weight	7.0kg	7.0kg
包装尺寸	Packing Size	750*365*165mm	750*365*165mm

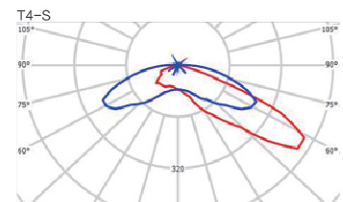
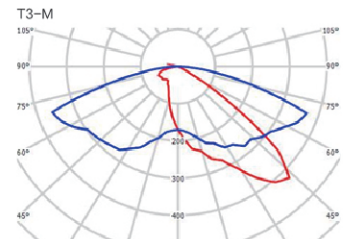
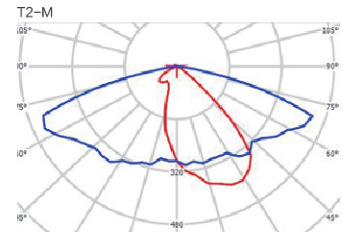

注意: 包装尺寸为外尺寸
 本表所示技术参数均在环境温度 25℃, 湿度 35% 的实验室环境中测得
 Packing size is outer size of box.
 eters are measured at 25℃ ambient, 35% humidity experimental environment



IP66 LED STREET LIGHT



JASS LARGE



金属灰 Metal Grey
砂纹黑 Black
闪银沙 silver

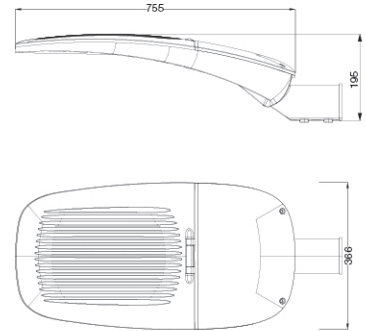

产品尺寸 Product Dimension



光控 (可选)
Photo cell
(optional)



无线单灯控制器 (可选)
Wireless single lamp controller
(optional)



防雷器 (可选)
Surge protector
(optional)



断电保护器 (可选)
Cut-off Switch(optional)

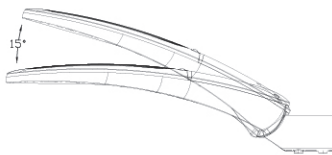

灯具水平安装, 可调角度为0-15°
Luminaire tilt adjustment, side entry: 0° to +15°

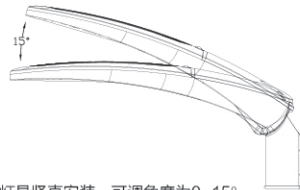

灯具竖直安装, 可调角度为0-15°
Luminaire tilt adjustment, post top: 0° to +15°

Features:

- Patented modern and fashionable streamline design
- Smooth type of roof is for excellent self-cleaning, to avoid bird droppings, falling leaves and sand storms.
- High quality ADC 12 aluminum die-casting and power painting.
- Top brand of LED components, CREE XTE or Lumileds 3030SMD.
- Correct optic lens family to satisfy any kind of road requirement.
- High quality LED power supply from Meanwell or Inventronics with 5-year warranty, including 6KV of surge protection. 10/20KV is possible with additional SPD.

产品技术参数表

Product Specification

产品型号	Product Code	BD-560150SJ	BD-560180SJ	BD-560200SJ
输入功率	Input Wattage	150W	180W	200W
LED 数量	LED quantity	72	80	96
色温	Color Temperature	3000-6500K	3000-6500K	3000-6500K
初始光通量	Luminous Flux	18000Lm ± 5%	21600Lm ± 5%	24000Lm ± 5%
输入电压	Input Voltage	AC100-277V	AC100-277V	AC100-277V
频率范围	Frequency Range	50/60Hz	50/60Hz	50/60Hz
功率因素	Power Factor	PF ≥ 0.9	PF ≥ 0.9	PF ≥ 0.9
显示指数	color rendering index	Ra ≥ 70	Ra ≥ 70	Ra ≥ 70
工作环境温度	Temperature of Working Condition	-40-50°C	-40-50°C	-40-50°C
工作环境湿度	Humidity of Working Condition	20%-90%	20%-90%	20%-90%
LED寿命	LED Lifetime	50000h	50000h	50000h
防护等级	Protectin Grade	IP66	IP66	IP66
安装管径	Installation Pipe Diameter	φ76mm	φ76mm	φ76mm
安装高度	Installation Height	10-12m	10-12m	10-12m
净重	Net Weight	11kg	11kg	11kg
毛重	Gross Weight	12.5kg	12.5kg	12.5kg
包装尺寸	Packing Size	910*430*200mm	910*430*200mm	910*430*200mm

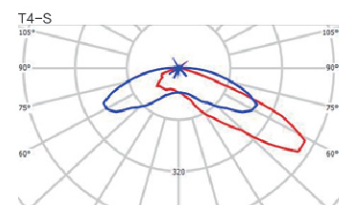
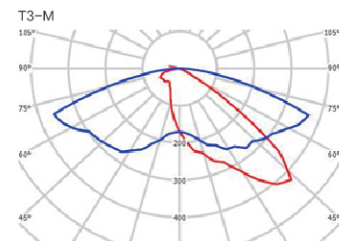
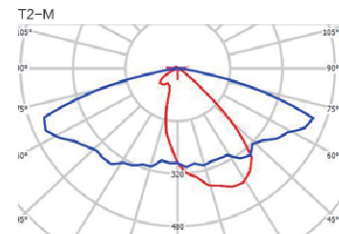

注意: 包装尺寸为外尺寸

本表所示技术参数均在环境温度为 25°C, 湿度 35% 的实验环境中测得

Packing size is outer size of box.
eters are measured at 25°C ambient, 35% humidity experimental environment

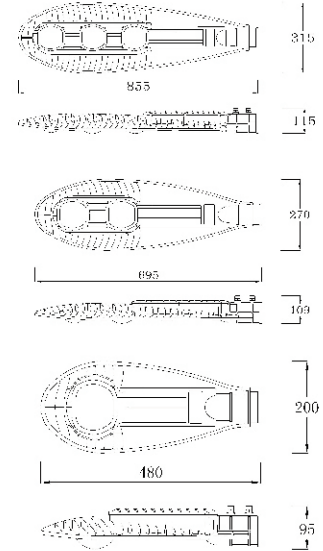
BAT

产品尺寸 Product Dimension

Features:

- High quality ADC 12 die-casting aluminum body and powder coating.
- High performance optical lens, high light transmittance, no glare.
- A full set of stainless steel fasteners, convenient installation
- Top brands of LED chip and power supply, Meanwell/ Inventronics to provide reliable quality with 5-year warranty.

产品技术参数表
Product Specification

产品型号	Product Code	BD-560050SK	BD-560100SK	BD-560150SK
输入功率	Input Wattage	50W	100W	150W
LED 数量	LED quantity	1COB	2COB	3COB
色温	Color Temperature	3000-6500K	3000-6500K	3000-6500K
初始光通量	Luminous Flux	5000Lm ± 5%	10000Lm ± 5%	15000Lm ± 5%
输入电压	Input Voltage	AC100-277V	AC100-277V	AC100-277V
频率范围	Frequency Range	50/60Hz	50/60Hz	50/60Hz
功率因素	Power Factor	PF ≥ 0.9	PF ≥ 0.9	PF ≥ 0.9
显示指数	color rendering index	Ra ≥ 70	Ra ≥ 70	Ra ≥ 70
工作环境温度	Temperature of Working Condition	-40--50℃	-40--50℃	-40--50℃
工作环境湿度	Humidity of Working Condition	20%-90%	20%-90%	20%-90%
LED寿命	LED Lifetime	50000h	50000h	50000h
防护等级	Protectin Grade	IP66	IP66	IP66
安装管径	Installation Pipe Diameter	φ60mm	φ60mm	φ60mm
安装高度	Installation Height	6-8m	8-10m	10-12m
净重	Net Weight	2.50kg	5.5kg	7.50kg
毛重	Gross Weight	3.0kg	6.50kg	8.50kg
包装尺寸	Packing Size	520*220*125mm	730*295*140mm	890*340*150mm

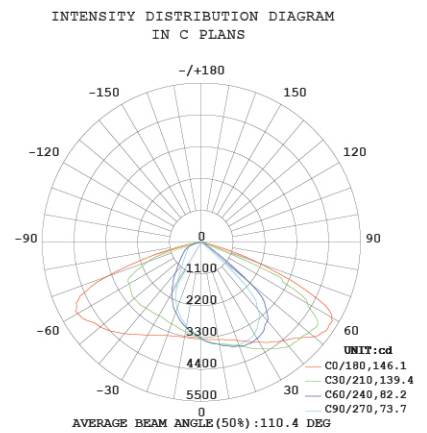

注意：包装尺寸为外尺寸

本表所示技术参数均在环境温度 25℃、湿度 35% 的实验室环境中测得

 Packing size is outer size of box.
 Parameters are measured at 25℃ ambient, 35% humidity experimental environment

MENO

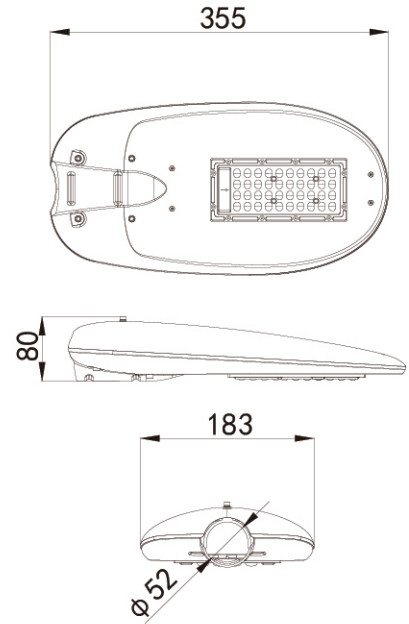

Features:

- Nice design with smooth roof
- High quality ADC 12 die-casting aluminum body and powder coating.
- High performance optical lens, high light transmittance, no glare.
- A full set of stainless steel fasteners, convenient installation
- Top brands of LED chip and power supply, Meanwell / Inventronics to provide reliable quality with 5-year warranty.

产品技术参数表 Product Specification

产品型号	Product Code	BD-560035SM	BD-560075SM
电流 (mA)	Electric current		
输入功率	Input Wattage	35W	75W
LED 数量	LED quantity	40	80
色温	Color Temperature	3000-6500K	3000-6500K
初始光通量	Luminous Flux	4500Lm ± 5%	9200Lm ± 5%
输入电压	Input Voltage	AC100-277V	AC100-277V
频率范围	Frequency Range	50/60Hz	50/60Hz
功率因素	Power Factor	PF ≥ 0.9	PF ≥ 0.9
显示指数	color rendering index	Ra ≥ 70	Ra ≥ 70
工作环境温度	Temperature of Working Condition	-40--50℃	-40--50℃
工作环境湿度	Humidity of Working Condition	20%-90%	20%-90%
LED寿命	LED Lifetime	50000h	50000h
防护等级	Protectin Grade	IP66	IP66
安装管径	Installation Pipe Diameter	φ 50mm	φ 60mm
安装高度	Installation Height	4-6m	6-8m
净重	Net Weight	1.70kg	3.5kg
毛重	Gross Weight	2.20kg	4.30kg
包装尺寸	Packing Size	490*385*420mm/10PCS	555*290*140mm

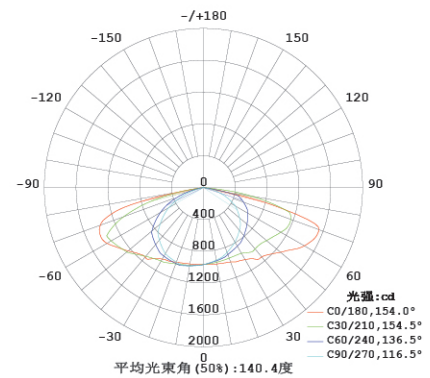

注意：包装尺寸为外尺寸
 本表所示技术参数均在环境温度 25℃，湿度 35% 的实验室环境中测得
 Packing size is outer size of box.
 Parameters are measured at 25℃ ambient, 35% humidity experimental environment

UFO



Flexible installation way

Available with tube installation, hanging and angle bracket installation.



Features:

Integration,minimalist & toughness design

- Integrated cold forging technology,precise plasticity.
- Improve the lamp's mechanical capacity and structural intensity
- Using higher purity industrial aluminum which is anti-corrosion & high-thermal conductivity.
- The complete lamp with electrophoretic processing,which has excellent anti-corrosion,stainless performance,and suitable for multi-complex working conditions.

产品技术参数表

Product Specification

产品型号	Product Code	BD-540100U	BD-540150U	BD-540200U
输入功率	Input Wattage	100W	150W	200W
LED 数量	LED quantity	192	192	240
色温	Color Temperature	3000-6500K	3000-6500K	3000-6500K
初始光通量	Luminous Flux	13000Lm ± 5%	18000Lm ± 5%	25000Lm ± 5%
输入电压	Input Voltage	AC100-277V	AC100-277V	AC100-277V
频率范围	Frequency Range	50/60Hz	50/60Hz	50/60Hz
功率因素	Power Factor	PF≥ 0.9	PF≥ 0.9	PF≥ 0.9
显示指数	color rendering index	Ra ≥ 70	Ra ≥ 70	Ra ≥ 70
工作环境温度	Temperature of Working Condition	-35--50℃	-35--50℃	-35--50℃
工作环境湿度	Humidity of Working Condition	10%-90%	10%-90%	10%-90%
LED寿命	LED Lifetime	50000h	50000h	50000h
防护等级	Protectin Grade	IP65	IP65	IP65
净重	Net Weight	2.50kg	3.20kg	3.20kg
毛重	Gross Weight	3.0kg	4.0kg	4.0kg
包装尺寸	Packing Size	300*300*180mm	300*300*180mm	300*300*180mm

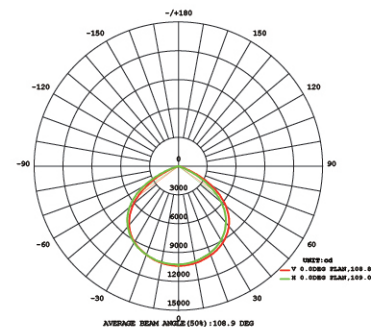

注意：包装尺寸为外尺寸

本表所示技术参数均在环境温度 25℃、湿度 35% 的实验室环境中测得

Packing size is outer size of box.
eters are measured at 25℃ ambient,35% humidity experimental environment

BAY

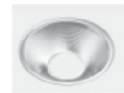

120° Φ 350

100° Φ 350

60° Φ 350

45° Φ 295

25° Φ 270

Features:

- High quality aluminum alloy housing with copper tube
- Excellent heat dissipation with good connection between LED mouldels and housing.
- Match with rectangular or round shaped LED driver, more choice ranges and applications.

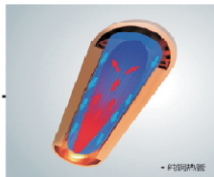

产品技术参数表

Product Specification

产品型号	Product Code	BD-540100B	BD-540150B	BD-540200B	BD-540250B
输入功率	Input Wattage	100W	150W	200W	250W
LED 数量	LED quantity	105	154	203	252
色温	Color Temperature	3000-6500K	3000-6500K	3000-6500K	3000-6500K
初始光通量	Luminous Flux	12000Lm±5%	18000Lm±5%	24000Lm±5%	30000Lm±5%
输入电压	Input Voltage	AC100-277V	AC100-277V	AC100-277V	AC100-277V
频率范围	Frequency Range	50/60Hz	50/60Hz	50/60Hz	50/60Hz
功率因素	Power Factor	PF ≥ 0.9	PF ≥ 0.9	PF ≥ 0.9	PF ≥ 0.9
显示指数	color rendering index	Ra ≥ 70	Ra ≥ 70	Ra ≥ 70	Ra ≥ 70
工作环境温度	Temperature of Working Condition	-35—50℃	-35—50℃	-35—50℃	-35—50℃
工作环境湿度	Humidity of Working Condition	10%-90%	10%-90%	10%-90%	10%-90%
LED寿命	LED Lifetime	50000h	50000h	50000h	50000h
防护等级	Protectin Grade	IP65	IP65	IP65	IP65
净重	Net Weight	2.60kg	3.30kg	4.30kg	5.10kg
毛重	Gross Weight	3.10kg	4.10kg	5.30kg	6.0kg
包装尺寸	Packing Size	255*255*280mm	255*255*310mm	255*255*350mm	255*255*390mm

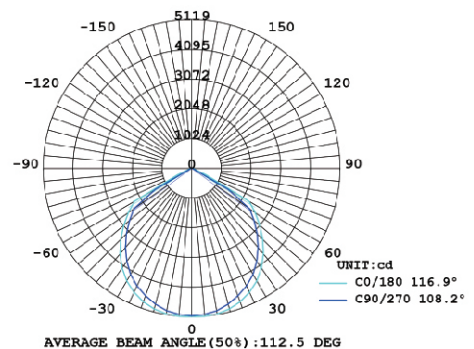

注意：包装尺寸为外尺寸

本表所示技术参数均在环境温度为 25℃，湿度 35% 的实验环境中测得

Packing size is outer size of box. Parameters are measured at 25℃ ambient, 35% humidity experimental environment

PIPE

Features:

- High quality aluminum alloy housing with copper tube
- Excellent heat dissipation with good connection between LED moulds and housing.
- Built-in power supply design, options for reflectors with different beam angle.



产品技术参数表 **Product Specification**

产品型号	Product Code	BD-540100P	BD-540150P	BD-540200P	BD-540250P	BD-540300P
输入功率	Input Wattage	100W	150W	200W	250W	300W
LED 数量	LED quantity	100	154	203	252	308
色温	Color Temperature	3000-6500K	3000-6500K	3000-6500K	3000-6500K	3000-6500K
初始光通量	Luminous Flux	12000Lm ± 5%	18000Lm ± 5%	24000Lm ± 5%	30000Lm ± 5%	36000Lm ± 5%
输入电压	Input Voltage	AC100-277V	AC100-277V	AC100-277V	AC100-277V	AC100-277V
频率范围	Frequency Range	50/60Hz	50/60Hz	50/60Hz	50/60Hz	50/60Hz
功率因素	Power Factor	PF ≥ 0.9	PF ≥ 0.9	PF ≥ 0.9	PF ≥ 0.9	PF ≥ 0.9
显示指数	color rendering index	Ra ≥ 70	Ra ≥ 70	Ra ≥ 70	Ra ≥ 70	Ra ≥ 70
工作环境温度	Temperature of Working Condition	-35--50°C	-35--50°C	-35--50°C	-35--50°C	-35--50°C
工作环境湿度	Humidity of Working Condition	10%-90%	10%-90%	10%-90%	10%-90%	10%-90%
LED寿命	LED Lifetime	50000h	50000h	50000h	50000h	50000h
防护等级	Protectin Grade	IP65	IP65	IP65	IP65	IP65
净重	Net Weight	3.30kg	3.70kg	4.50kg	5.80kg	7.0kg
毛重	Gross Weight	3.70kg	4.30kg	5.30kg	6.80kg	8.0kg
包装尺寸	Packing Size	255*255*360mm	255*255*390mm	255*255*435mm	300*300*420mm	300*300*460mm

注意：包装尺寸为外尺寸

本表所示技术参数均在环境温度为 25℃、湿度 35% 的实验室环境中测得

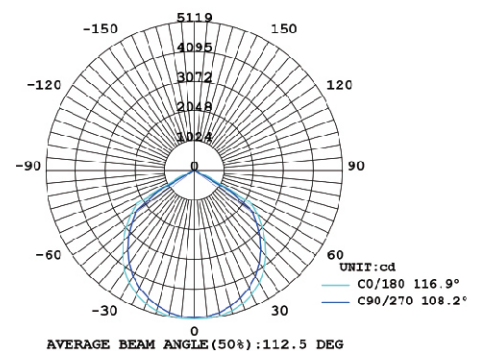
Packing size is outer size of box.
 eters are measured at 25°C ambient, 35% humidity experimental environment



LED LINEAR HIGH BAY LIGHT

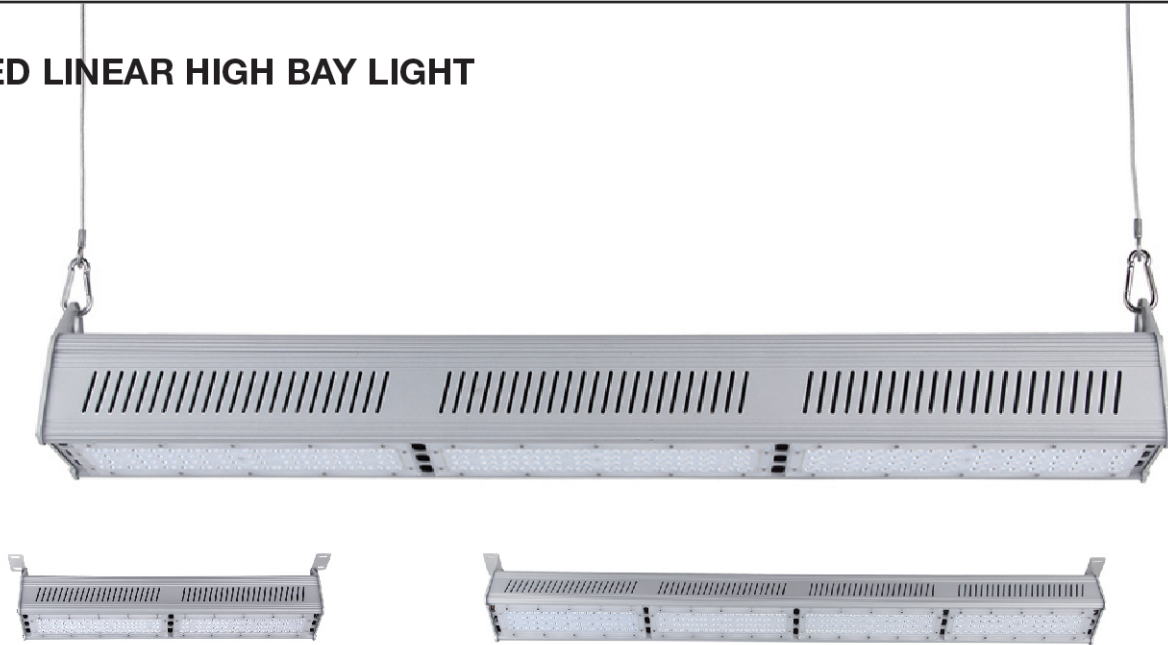

Features:

- High quality aluminum alloy housing
- Excellent heat dissipation with good connection between LED mouldels and housing.
- Waterproof degree IP65
- Two different fixing
- 7 kinds of optical lense with beam angle 60°120,60°90,30°70,155°80,90,60 and 30 degree.to meet different optics requirement.

产品技术参数表 Product Specification

产品型号	Product Code	BD-540050L	BD-540100L	BD-540150L	BD-540200L	BD-540250L
输入功率	Input Wattage	50W	100W	150W	200W	250W
LED 数量	LED quantity	56	112	168	224	280
色温	Color Temperature	3000-6500K	3000-6500K	3000-6500K	3000-6500K	3000-6500K
初始光通量	Luminous Flux	7500Lm ± 5%	15000Lm ± 5%	22500Lm ± 5%	30000Lm ± 5%	37000Lm ± 5%
输入电压	Input Voltage	AC100-277V	AC100-277V	AC100-277V	AC100-277V	AC100-277V
频率范围	Frequency Range	50/60Hz	50/60Hz	50/60Hz	50/60Hz	50/60Hz
功率因素	Power Factor	PF ≥ 0.9	PF ≥ 0.9	PF ≥ 0.9	PF ≥ 0.9	PF ≥ 0.9
显示指数	color rendering index	Ra ≥ 70	Ra ≥ 70	Ra ≥ 70	Ra ≥ 70	Ra ≥ 70
工作环境温度	Temperature of Working Condition	-35--50℃	-35--50℃	-35--50℃	-35--50℃	-35--50℃
工作环境湿度	Humidity of Working Condition	10%-90%	10%-90%	10%-90%	10%-90%	10%-90%
LED寿命	LED Lifetime	50000h	50000h	50000h	50000h	50000h
防护等级	Protectin Grade	IP65	IP65	IP65	IP65	IP65
净重	Net Weight	1.50kg	2.80kg	3.80kg	5.0kg	6.0kg
毛重	Gross Weight	2.0kg	3.50kg	4.50kg	5.80kg	7.0kg
包装尺寸	Packing Size	385*165*195mm	650*165*195mm	920*165*195mm	1185*165*195mm	1450*165*195

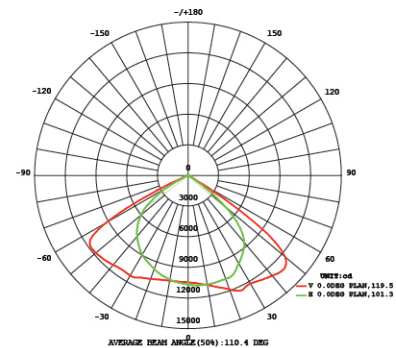

注意：包装尺寸为外尺寸
 本表所示技术参数均在环境温度 25℃、湿度 35% 的实验室环境中测得
 Packing size is outer size of box.
 eters are measured at 25℃ ambient,35% humidity experimental environment

LANTERN

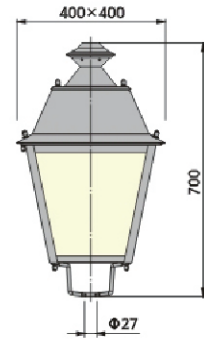

产品尺寸 Product Dimension

Features:

- Classical design of lantern
- Galvanized steel plate after jointing and welding of body
- Mechanical and chemical anti-corrosion treatment, UV resistant exterior painting system
- Optics: Anodized aluminum reflector and PMMA diffuser

产品技术参数表
Product Specification

产品型号	Product Code	BD-550040L	BD-550060L	BD-550100L
输入功率	Input Wattage	40W	60W	100W
色温	Color Temperature	3000-6500K	3000-6500K	3000-6500K
初始光通量	Luminous Flux	3800Lm ± 5%	5700Lm ± 5%	9500Lm ± 5%
输入电压	Input Voltage	AC100-277V	AC100-277V	AC100-277V
频率范围	Frequency Range	50/60Hz	50/60Hz	50/60Hz
功率因素	Power Factor	PF ≥ 0.9	PF ≥ 0.9	PF ≥ 0.9
显示指数	color rendering index	Ra ≥ 70	Ra ≥ 70	Ra ≥ 70
工作环境温度	Temperature of Working Condition	-35--50℃	-35--50℃	-35--50℃
工作环境湿度	Humidity of Working Condition	20%-90%	20%-90%	20%-90%
LED寿命	LED Lifetime	50000h	50000h	50000h
防护等级	Protectin Grade	IP65	IP65	IP65
安装管径	Installation Pipe Diameter	φ 60mm	φ 60mm	φ 60mm
净重	Net Weight	5.60kg	6.30kg	6.60kg
包装尺寸	Packing Size	440*440*740mm	440*440*740mm	440*440*740mm

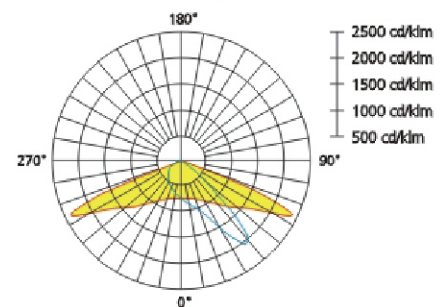

注意：包装尺寸为外尺寸

本表所示技术参数均在环境温度 25℃、湿度 35% 的实验室环境中测得

 Packing size is outer size of box.
 eters are measured at 25℃ ambient, 35% humidity experimental environment

SALLOW

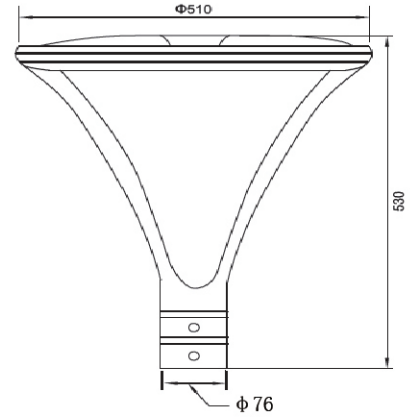

产品尺寸 Product Dimension

Features:

- The Modern and fashionable desing,it's a nice scene of garden and city
- High efficient integrated heat radiation design,Electrostatic powder painting high strength anti-corrosion, longlife span.
- High efficient LED chips and LED power supply,reasonable light distribution technology,make the lamp more high performance and practicality.
- High transparent toughened glass,high transmittance,high strength,impact resistance.

产品技术参数表 Product Specification

产品型号	Product Code	BD-550035S	BD-550060S	BD-550100S
输入功率	Input Wattage	35W	60W	100W
LED 数量	LED quantity	24	32	48
色温	Color Temperature	3000-6500K	3000-6500K	3000-6500K
初始光通量	Luminous Flux	2600Lm ± 5%	4600Lm ± 5%	7800Lm ± 5%
输入电压	Input Voltage	AC100-277V	AC100-277V	AC100-277V
频率范围	Frequency Range	50/60Hz	50/60Hz	50/60Hz
功率因素	Power Factor	PF ≥ 0.9	PF ≥ 0.9	PF ≥ 0.9
显示指数	color rendering index	Ra ≥ 70	Ra ≥ 70	Ra ≥ 70
工作环境温度	Temperature of Working Condition	-35--50℃	-35--50℃	-35--50℃
工作环境湿度	Humidity of Working Condition	20%-90%	20%-90%	20%-90%
LED寿命	LED Lifetime	50000h	50000h	50000h
防护等级	Protectin Grade	IP65	IP65	IP65
安装管径	Installation Pipe Diameter	Φ 76mm	Φ 76mm	Φ 76mm
净重	Net Weight	8.0kg	8.0kg	8.0kg
包装尺寸	Packing Size	530*530*550mm	530*530*550mm	530*530*550mm

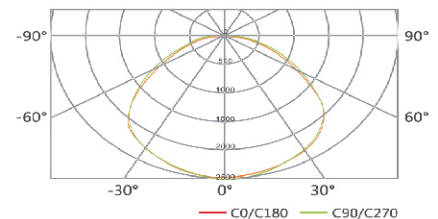

注意：包装尺寸为外尺寸
 本表所示技术参数均在环境温度为 25℃，湿度 35% 的实验环境中测得
 Packing size is outer size of box.
 Parameters are measured at 25℃ ambient, 35% humidity experimental environment

PANDORA

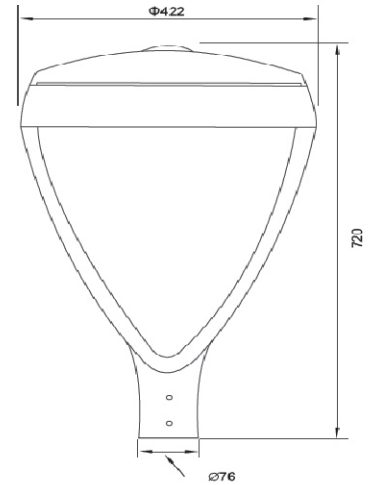

产品尺寸 Product Dimension

Features:

- The Modern and fashionable desing,it's a nice scene of garden and city
- High efficient integrated heat radiation design,Electrostatic powder painting high strength anti-corrosion, longlife span.
- High efficient LED chips and LED power supply,reasonable light distribution technology,make the lamp more high performance and practicality.
- High transparent toughened glass,high transmittance,high strength,impact resistance.

产品技术参数表
Product Specification

产品型号	Product Code	BD-550035P	BD-550060P	BD-550100P
输入功率	Input Wattage	35W	60W	100W
LED 数量	LED quantity	24	32	48
色温	Color Temperature	3000-6500K	3000-6500K	3000-6500K
初始光通量	Luminous Flux	2600Lm ± 5%	4800Lm ± 5%	7800Lm ± 5%
输入电压	Input Voltage	AC100-277V	AC100-277V	AC100-277V
频率范围	Frequency Range	50/60Hz	50/60Hz	50/60Hz
功率因素	Power Factor	PF ≥ 0.9	PF ≥ 0.9	PF ≥ 0.9
显示指数	color rendering index	Ra ≥ 70	Ra ≥ 70	Ra ≥ 70
工作环境温度	Temperature of Working Condition	-35--50℃	-35--50℃	-35--50℃
工作环境湿度	Humidity of Working Condition	20%-90%	20%-90%	20%-90%
LED寿命	LED Lifetime	50000h	50000h	50000h
防护等级	Protectin Grade	IP65	IP65	IP65
安装管径	Installation Pipe Diameter	φ 76mm	φ 76mm	φ 76mm
净重	Net Weight	8.50kg	8.50kg	8.50kg
包装尺寸	Packing Size	780*450*450mm	780*450*450mm	780*450*450mm

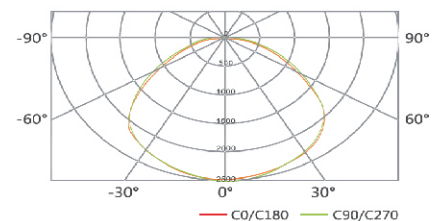

注意：包装尺寸为外尺寸

本表所示技术参数均在环境温度为 25℃，湿度 35% 的实验室环境中测得

Packing size is outer size of box.
 elers are measured at 25℃ ambient,35% humidity experimental environment

YATE

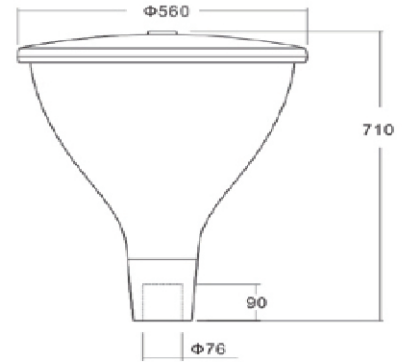

产品尺寸 Product Dimension

Features:

- The Modern and fashionable desing,it's a nice scene of garden and city
- High efficient integrated heat radiation design,Electrostatic powder painting high strength anti-corrosion, longlife span.
- High efficient LED chips and LED power supply,reasonable light distribution technology,make the lamp more high performance and practicality.
- High transparent toughened glass,high transmittance,high strength,impact resistance.

产品技术参数表 Product Specification

产品型号	Product Code	BD-550035Y	BD-550045Y	BD-550060Y
输入功率	Input Wattage	35W	45W	60W
LED 数量	LED quantity	16	20	28
色温	Color Temperature	3000-6500K	3000-6500K	3000-6500K
初始光通量	Luminous Flux	3300Lm ± 5%	4200Lm ± 5%	5700Lm ± 5%
输入电压	Input Voltage	AC100-277V	AC100-277V	AC100-277V
频率范围	Frequency Range	50/60Hz	50/60Hz	50/60Hz
功率因素	Power Factor	PF ≥ 0.9	PF ≥ 0.9	PF ≥ 0.9
显示指数	color rendering index	Ra ≥ 70	Ra ≥ 70	Ra ≥ 70
工作环境温度	Temperature of Working Condition	-35--50℃	-35--50℃	-35--50℃
工作环境湿度	Humidity of Working Condition	20%-90%	20%-90%	20%-90%
LED寿命	LED Lifetime	50000h	50000h	50000h
防护等级	Protectin Grade	IP65	IP65	IP65
安装管径	Installation Pipe Diameter	φ 76mm	φ 76mm	φ 76mm
净重	Net Weight	9.20kg	9.20kg	9.20kg
包装尺寸	Packing Size	605*605*750mm	605*605*750mm	605*605*750mm

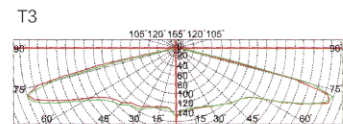
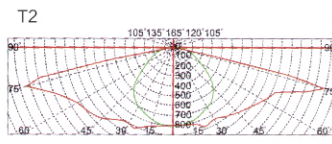
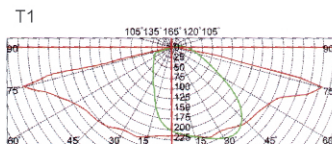

注意：包装尺寸为外尺寸
 本表所示技术参数均在环境温度为 25℃，湿度 35% 的实验室环境中测得
 Packing size is outer size of box.
 eters are measured at 25℃ ambient,35% humidity experimental environment

MINK

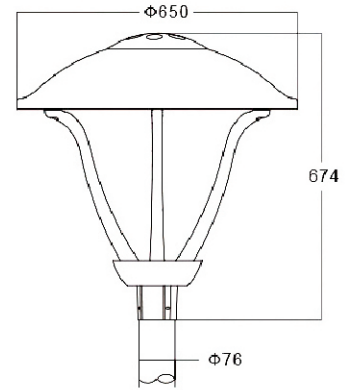

产品尺寸 Product Dimension

Features:

- The Modern and fashionable desing,it's a nice scene of garden and city
- High efficient integrated heat radiation design,Electrostatic powder painting high strength anti-corrosion, longlife span.
- High efficient LED chips and LED power supply,reasonable light distribution technology,make the lamp more high performance and practicality.
- High transparent toughened glass,high transmittance,high strength,impact resistance.

产品技术参数表

Product Specification

产品型号	Product Code	BD-550030M	BD-550040M	BD-550050M
输入功率	Input Wattage	30W	40W	50W
LED 数量	LED quantity	18	24	30
色温	Color Temperature	3000-6500K	3000-6500K	3000-6500K
初始光通量	Luminous Flux	3100Lm \pm 5%	4200Lm \pm 5%	5200Lm \pm 5%
输入电压	Input Voltage	AC100-277V	AC100-277V	AC100-277V
频率范围	Frequency Range	50/60Hz	50/60Hz	50/60Hz
功率因素	Power Factor	PF \geq 0.9	PF \geq 0.9	PF \geq 0.9
显示指数	color rendering index	Ra \geq 70	Ra \geq 70	Ra \geq 70
工作环境温度	Temperature of Working Condition	-35--50 $^{\circ}$ C	-35--50 $^{\circ}$ C	-35--50 $^{\circ}$ C
工作环境湿度	Humidity of Working Condition	20%-90%	20%-90%	20%-90%
LED寿命	LED Lifetime	50000h	50000h	50000h
防护等级	Protectin Grade	IP65	IP65	IP65
安装管径	Installation Pipe Diameter	ϕ 76mm	ϕ 76mm	ϕ 76mm
净重	Net Weight	10.50kg	10.50kg	10.50kg
包装尺寸	Packing Size	700x700x720mm	700x700x720mm	700x700x720mm

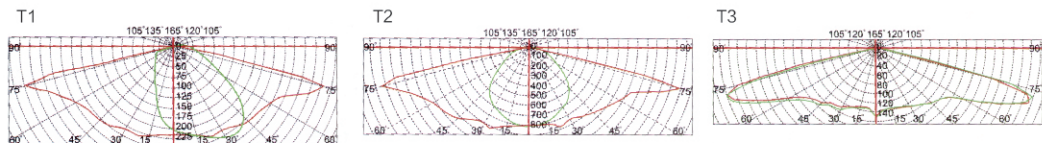

注意: 包装尺寸为外尺寸

 本表所示技术参数均在环境温度为 25 $^{\circ}$ C. 湿度 35% 的实验环境中测得

 Packing size is outer size of box.
 elters are measured at 25 $^{\circ}$ C ambient,35% humidity experimental environment

C SERIES



Features:

- Ultra-slim sleek design, stylish and classic
- Totally 8 models, full range from 10W to 200W.
- Pure aluminium structure for good heat dissipation
- Professional optical design, lumious efficiency is 50% up
- Innovative G-buckle technology, prevent glass off.



产品技术参数表 Product Specification

产品型号	Product Code	BD-530010C	BD-530020C	BD-530030C	BD-530050C	BD-530080C	BD-530100C	BD-530150C	BD-530200C
输入功率	Input Wattage	10W	20W	30W	50W	80W	100W	150W	200W
LED 数量	LED quantity	10	20	30	50	80	100	150	240
色温	Color Temperature	3000-6500K	3000-6500K	3000-6500K	3000-6500K	3000-6500K	3000-6500K	3000-6500K	3000-6500K
初始光通量	Luminous Flux	1200Lm ± 5%	2400Lm ± 5%	3600Lm ± 5%	6000Lm ± 5%	9600Lm ± 5%	12000Lm ± 5%	18000Lm ± 5%	24000Lm ± 5%
输入电压	Input Voltage	AC100-277V	AC100-277V	AC100-277V	AC100-277V	AC100-277V	AC100-277V	AC100-277V	AC100-277V
频率范围	Frequency Range	50/60Hz	50/60Hz	50/60Hz	50/60Hz	50/60Hz	50/60Hz	50/60Hz	50/60Hz
功率因素	Power Factor	PF ≥ 0.5	PF ≥ 0.5	PF ≥ 0.9	PF ≥ 0.9	PF ≥ 0.9	PF ≥ 0.9	PF ≥ 0.9	PF ≥ 0.9
显示指数	color rendering index	Ra ≥ 70	Ra ≥ 70	Ra ≥ 70	Ra ≥ 70	Ra ≥ 70	Ra ≥ 70	Ra ≥ 70	Ra ≥ 70
工作环境温度	Temperature of Working Condition	-35--50℃	-35--50℃	-35--50℃	-35--50℃	-35--50℃	-35--50℃	-35--50℃	-35--50℃
工作环境湿度	Humidity of Working	10%-90%	10%-90%	10%-90%	10%-90%	10%-90%	10%-90%	10%-90%	10%-90%
LED寿命	LED Lifetime	50000h	50000h	50000h	50000h	50000h	50000h	50000h	50000h
防护等级	Protectin Grade	IP65	IP65	IP65	IP65	IP65	IP65	IP65	IP65
包装尺寸	Packing Size	425*415*255mm/ 36pcs	515*380*260mm/ 20pcs	535*405*260mm/ 20pcs	530*365*255mm/ 8pcs	435*340*130mm/ 1pcs	510*430*135 mm/1pcs	510*430*135 mm/1pcs	555*460*135 mm/1pcs

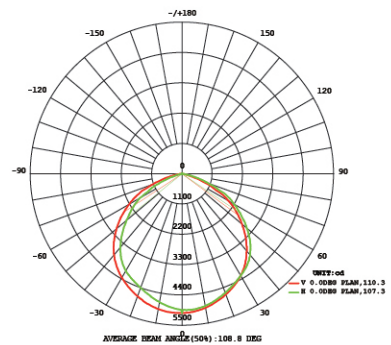

注意：包装尺寸为外尺寸
 本表所示技术参数均在环境温度 25℃、湿度 35% 的实验环境中测得
 Packing size is outer size of box.
 eters are measured at 25℃ ambient, 35% humidity experimental environment

G SERIES

Features:

- Unique modern and fashionable streamline design
- High quality ADC 12 aluminum die-casting and power painting. Impact grade reached IK08
- Waterproof grade IP65
- Lumileds & Inventronics provide reliable quality 5-year warranty.

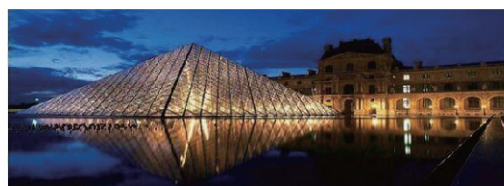
产品技术参数表
Product Specification

产品型号	Product Code	BD-530010G	BD-530030G	BD-530050G	BD-530100G	BD-530150G	BD-530200G	BD-530300G
输入功率	Input Wattage	10W	30W	50W	100W	150W	200W	300W
LED 数量	LED quantity	20	60	110	220	180	247	351
产品尺寸	Product Size	170*130*40mm	200*160*45mm	240*200*50mm	300*245*60mm	360*300*70mm	440*370*90mm	540*435*100mm
色温	Color Temperature	3000-6500K	3000-6500K	3000-6500K	3000-6500K	3000-6500K	3000-6500K	3000-6500K
初始光通量	Luminous Flux	1100Lm ± 5%	3300Lm ± 5%	5500Lm ± 5%	11000Lm ± 5%	16500Lm ± 5%	22000Lm ± 5%	33000Lm ± 5%
输入电压	Input Voltage	AC100-277V	AC100-277V	AC100-277V	AC100-277V	AC100-277V	AC100-277V	AC100-277V
频率范围	Frequency Range	50/60Hz	50/60Hz	50/60Hz	50/60Hz	50/60Hz	50/60Hz	50/60Hz
功率因素	Power Factor	PF ≥ 0.5	PF ≥ 0.5	PF ≥ 0.9	PF ≥ 0.9	PF ≥ 0.9	PF ≥ 0.9	PF ≥ 0.9
显示指数	color rendering index	Ra ≥ 70	Ra ≥ 70	Ra ≥ 70	Ra ≥ 70	Ra ≥ 70	Ra ≥ 70	Ra ≥ 70
工作环境温度	Temperature of Working Condition	-35--50℃	-35--50℃	-35--50℃	-35--50℃	-35--50℃	-35--50℃	-35--50℃
工作环境湿度	Humidity of Working	10%-90%	10%-90%	10%-90%	10%-90%	10%-90%	10%-90%	10%-90%
LED寿命	LED Lifetime	50000h	50000h	50000h	50000h	50000h	50000h	50000h
防护等级	Protectin Grade	IP65	IP65	IP65	IP65	IP65	IP65	IP65

注意：包装尺寸为外尺寸

本表所示技术参数均在环境温度为 25℃、湿度 35% 的实验环境中测得

Packing size is outer size of box.

eters are measured at 25℃ ambient, 35% humidity experimental environment

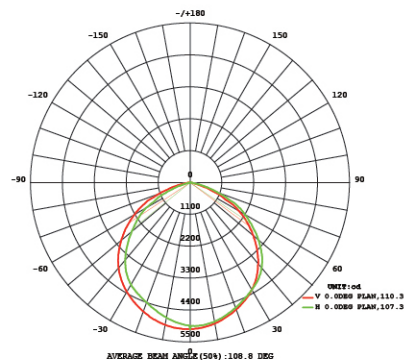

TUNE

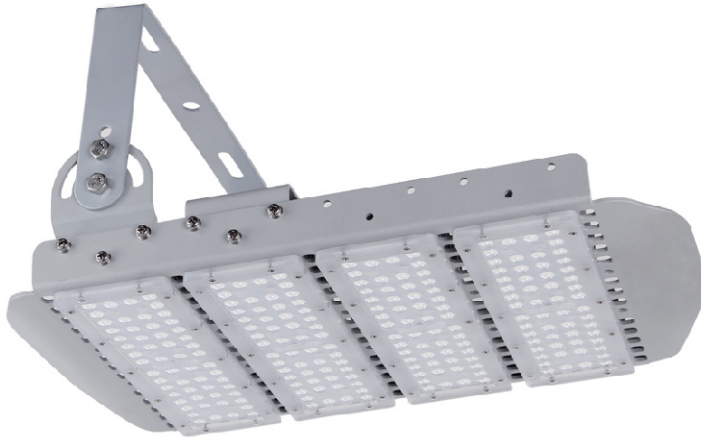

Features:

- High quality aluminum alloy housing
- Excellent heat dissipation with good connection between LED mouldels and housing.
- Waterproof degree IP66
- 7 kinds of optical lense with beam angle 60°120,60°90,30°70,155°80,90,60 and 30 degree. to meet different optics requirement.



产品技术参数表 Product Specification

产品型号	Product Code	BD-530050T	BD-530100T	BD-530150T	BD-530200	BD-530250T	BD-530300T
输入功率	Input Wattage	50W	100W	150W	200W	250W	300W
LED 数量	LED quantity	56	112	168	224	280	336
色温	Color Temperature	3000-6500K	3000-6500K	3000-6500K	3000-6500K	3000-6500K	3000-6500K
初始光通量	Luminous Flux	6000Lm±5%	12000Lm±5%	18000Lm±5%	24000Lm±	30000Lm±5%	36000Lm±5%
输入电压	Input Voltage	AC100-277V	AC100-277V	AC100-277V	AC100-	AC100-277V	AC100-277V
频率范围	Frequency Range	50/60Hz	50/60Hz	50/60Hz	50/60Hz	50/60Hz	50/60Hz
功率因素	Power Factor	PF≥0.5	PF≥0.5	PF≥0.9	PF≥0.9	PF≥0.9	PF≥0.9
显示指数	color rendering index	Ra≥70	Ra≥70	Ra≥70	Ra≥70	Ra≥70	Ra≥70
工作环境温度	Temperature of Working Condition	-35--50℃	-35--50℃	-35--50℃	-35--50℃	-35--50℃	-35--50℃
工作环境湿度	Humidity of Working	10%-90%	10%-90%	10%-90%	10%-90%	10%-90%	10%-90%
LED寿命	LED Lifetime	50000h	50000h	50000h	50000h	50000h	50000h
防护等级	Protectin Grade	IP65	IP65	IP65	IP65	IP65	IP65
包装尺寸	Packing Size	275*350*150	345*350*150mm	420*350*150mm	510*350*15	600*350*150mm	690*350*150mm

注意：包装尺寸为外尺寸
本表所示技术参数均在环境温度为 25℃，湿度 35% 的实验环境中测得

Packing size is outer size of box.
eters are measured at 25℃ ambient,35% humidity experimental environment

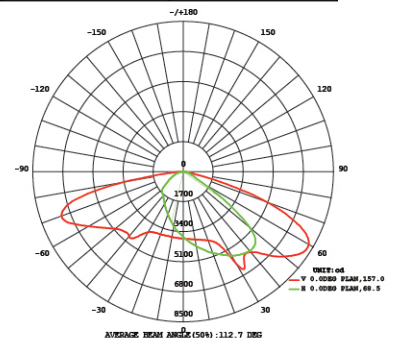

SMART CONTROL CLOUD SYSTEM (SCCS)

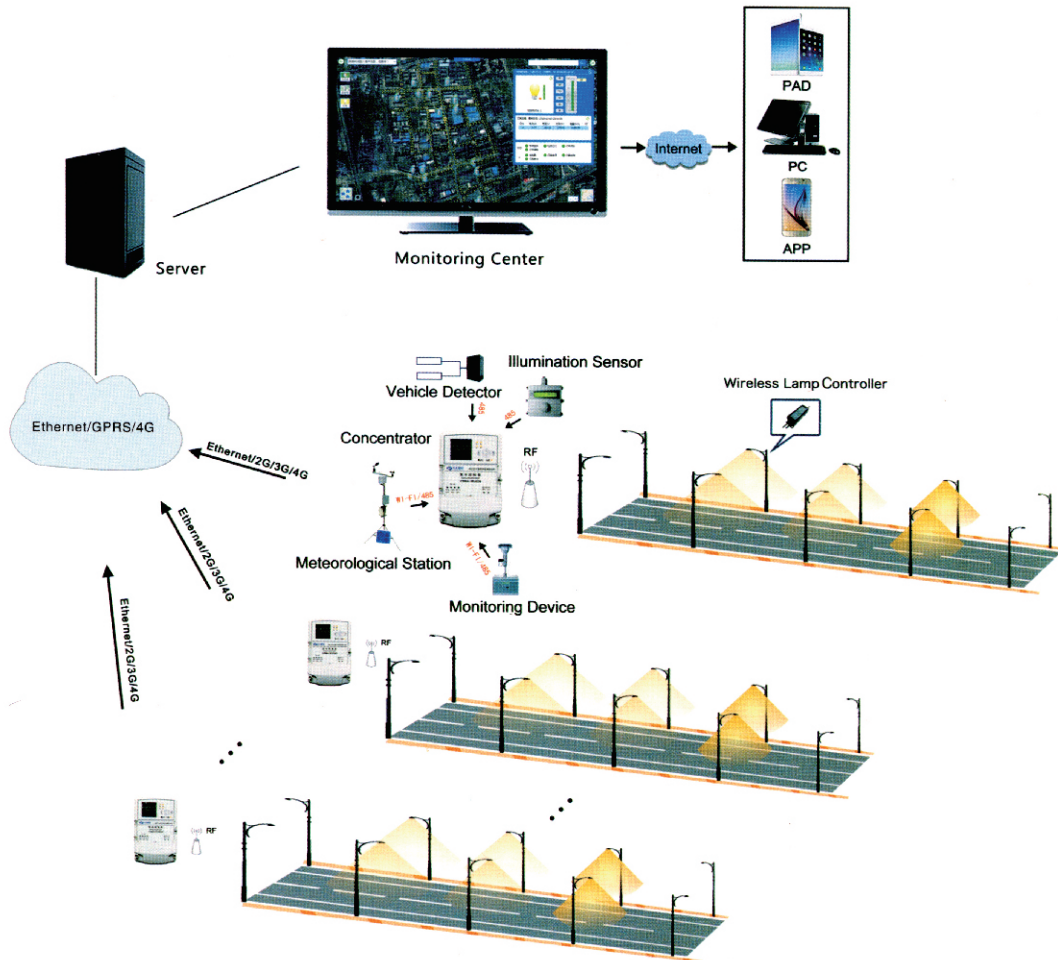

1. Brief introduction

Smart lighting cloud control system (SCCS) is a web-based solution with advanced communication and easy integration with existing installations, can monitor individual luminaries up to millions of points of light. It facilitates reduction in power consumption, CO2 emission and light pollution and moreover an optimized maintenance planning.

Features:

- Fault alarms, easy installation, lamp and line status, power quality metering and remote monitoring.
- Energy and cost saving result from dimming at off-peak traffic hours, reduced maintenance costs, accurate switch ON/OFF.
- Powerful software with GPS mapping

2. Products

1)SCCS Monitoring Software

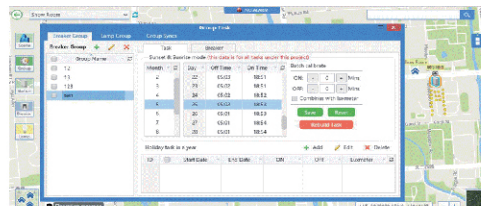
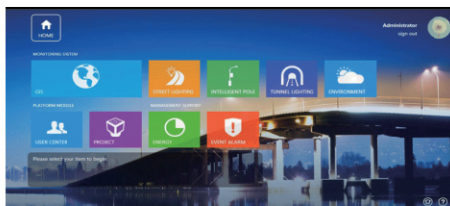

- Central interface between user and the SCCS system
- Administration, programming and analysis of the lighting system
- Local installation or in the cloud
- Only allocated function areas visible for each user.

2)SCCS concentrator



PLC/ZIGBEE (Powerline Communication)

Product	Model	Character	Size(mm)
concentrator	FONDA-RTU200	PLC,with LCD display	288x177x95
	FONDA-RTU200Z	PLC,WIFI LCD display	288x177x95

- Smart remote control by:longitude/Latitude,Light, Time or Longitude/Latitude combined with light.
- Fault alarms: light-on by accident, light-off by accident, power failure, power on, leakage, over voltage, under voltage, over current, AC contactor failure, breaker failure, cabinet tilt, water in cabinet, cabinet door open, etc.
- Built-in meter: detection for voltage, current and electrical energy data.
- Support external smart power meter.
- Support remote & local update.
- UP communication: 2G/3G/4G, Down communication: PLC, Zigbee, RS485.
- Support external battery which can run for 8 hours after power off.

3) SCCS lamp controller



FONDA-LCU15



FONDA-LCU51Z



FONDA-LCU16Z

PLC/ZIGBEE (Powerline Communication)

Product	Model	Character	Size(mm)
Single Lamp Controller	FONDA-LCU15	PWM dimming,PLC,IP65 96V-264VAC	172X56X51
	FONDA-LCU51Z	PWM/0-10Vdimming,Zigbee, IP67,90V-264VAC	172X56X40
	FONDA-LCU16Z	PWM/0-10Vdimming,Zigbee, IP67,90V-264VAC	84X84X98

Features:

- PLC, Zigbee communication, frequency of 2.4G, 915M
- Controlling and monitoring of each light
- Current, voltage, power, power consumption remote reading
- Fault alarms: lamp failure, under voltage, over current, lamp life-time warning



宁波乐博达光电科技有限公司

地址：中国·宁波市望春工业园区科茂路430号

电话：+86-574-8815 5929 传真：+86-574-8802 1997

邮箱：tony@lebodaworld.com 网址：www.lebodaworld.com

Ningbo Leboda Lighting Technology Co.,Ltd

Add:No.430,Kemao Road,Wangchun Industrial Zone,
Ningbo, 315171, P.R.China.

T: +86-574-8815 5929 F: +86-574-8802 1997

E: tony@lebodaworld.com Http://www.lebodaworld.com